

**100 to 1,000 amp DC Connectors used in:**

**Batteries & Energy Storage**



**Work Trucks, APUs, Electrification**



**Motive Power**



Rebling is a connector manufacturer located near Philadelphia which has specialized in high current (100 to 1,000 amps) connectors for the past 50 years. Fortunately for us, there has been significant growth in the markets we serve (battery manufacturers, motive power, energy storage systems, auxiliary power, power conditioning).

As applications trend toward higher voltages and currents as well as faster charging times, improved features are needed to enable the OEMs in those sectors to maintain their competitive edge and reduce their end users' total cost of ownership. We will continue to innovate and bring those vital features to market at economical prices.

**Wherever you find a Lithium Battery Module larger than a loaf of bread, you will find Rebling**



**DC Power Converters**

**Tugs & Tractors**

**Lithium Batteries**

**EV Fast Chargers**

**Portable Battery Packs**

**Forklifts & AGVs**

**Mining Vehicles**

**High Performance EVs**

**Energy Storage Systems**

**Marine Micro Grids**

**Long Haul BEVs**

**Pulse Weapons**

**Zero Emission Work Trucks**



**Generator Sets**



**Off-Grid Backup**

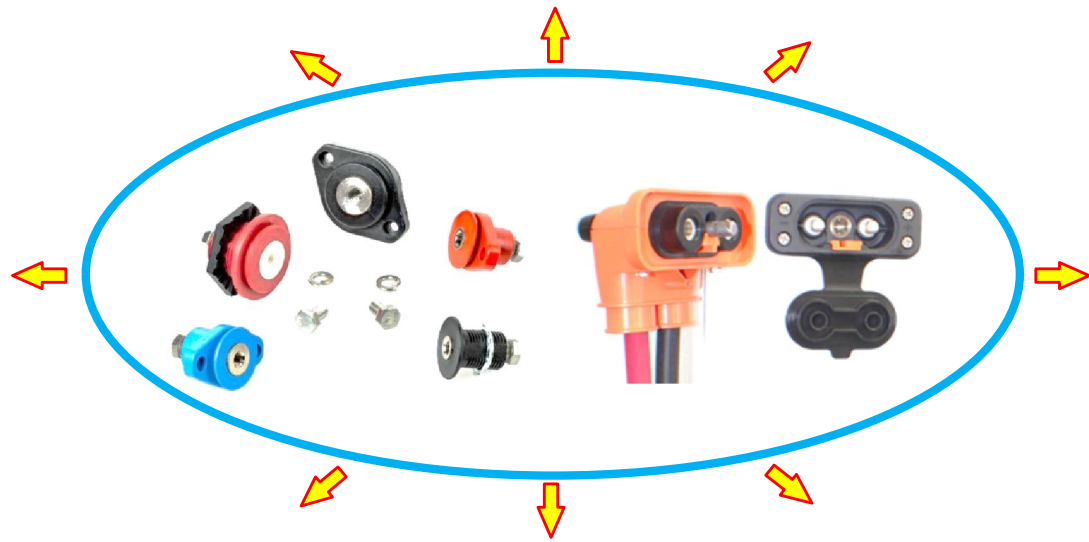

**Double Pole  
Quick-Disconnect Connectors**



pages 16 → 22

**Single Pole  
Feed Through Terminals**

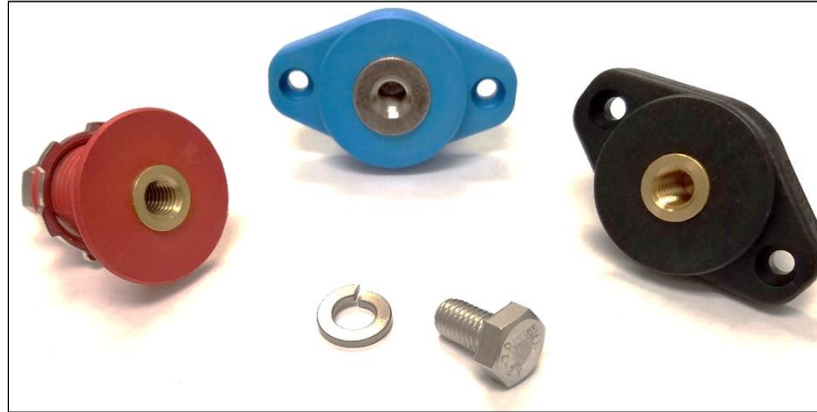

pages 4 → 15

**Battery Swap  
Connectors**



pages 21 → 22

**Double Pole Renewable Energy  
Inverter Connectors**

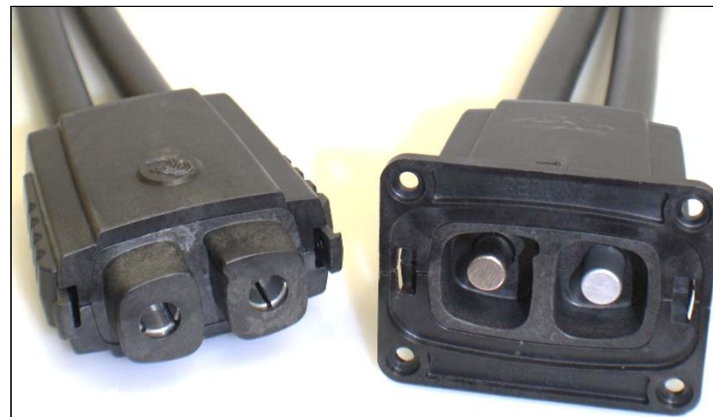

**Datasheets and 3D Step Files**  
for all products can be  
Downloaded from [Rebling.com](http://Rebling.com)

## Feed Through Terminal, Single Pole, Wrench-Disconnect

### TFT, LFT, SFT, Top Seal, MFT, BFT and XFT Styles



Our terminals are designed for the temperature sensitive environment of lithium battery modules and are compatible with any battery chemistry as well as air-cooled or liquid-cooled systems. Available in nickel plated for harsh environments, they prevent the ingress or egress of fluids and stay cool even at extreme charge and discharge rates. Equipping your design with these watertight terminals will enable designers and integrators to easily incorporate your products into Battery Pack, Motive Power, Energy Storage, Auxiliary Power or Power Conditioning applications.

The **Selection Guides** on pages 8 - 10 identify the optimal part based upon your application's rated current, panel material, panel thickness, desired mounting pattern, environmental sealing and cover requirements.

Rigid and flexible covers snap onto the terminals with an audible click.

**Ordering Information** for terminals and accessories can be found on pages 11 - 15



# Feed-through Terminals in an Energy Storage System

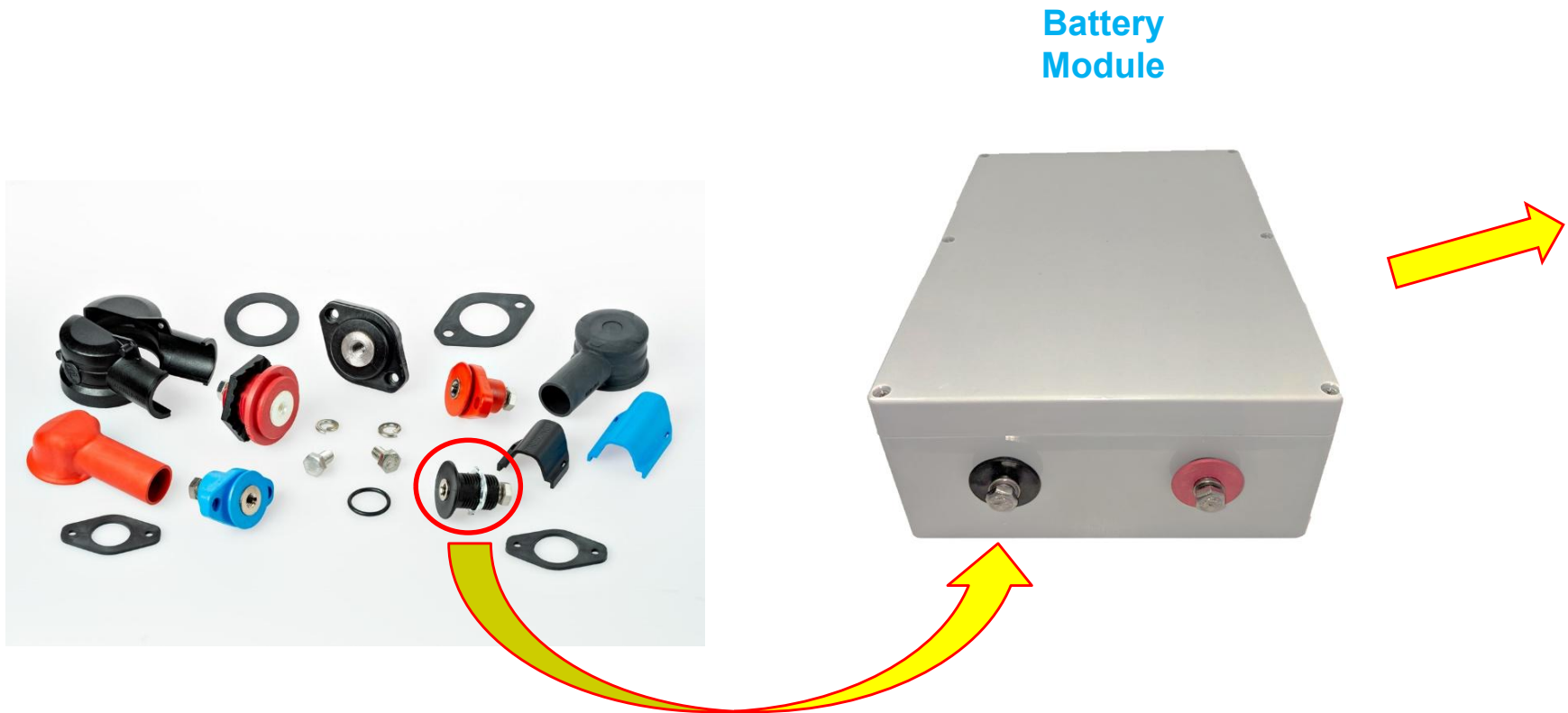

Battery Module



Multiple Module Stack

# Feed-through Terminals in a Battery Module

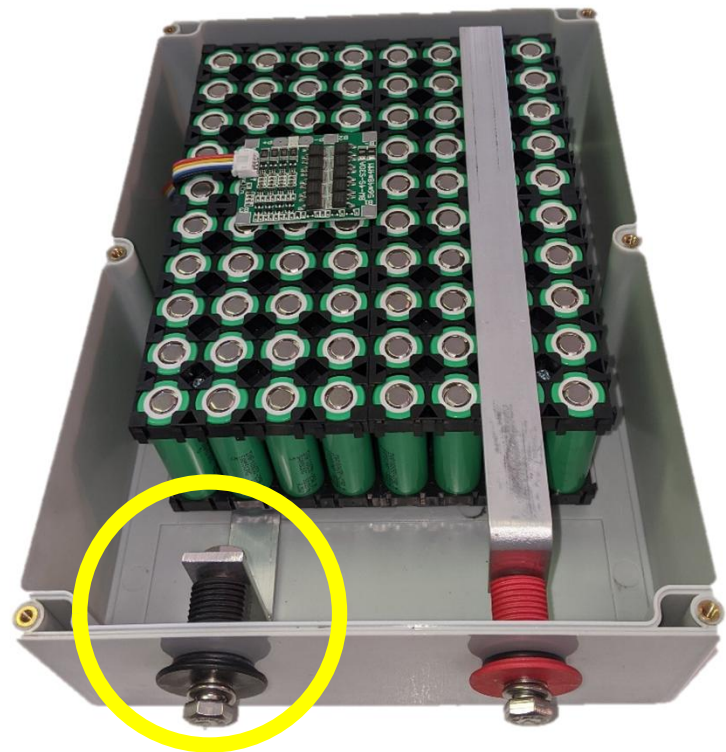
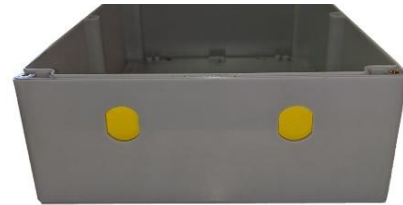

# Feed-through Terminals in a Multiple-module Battery Pack

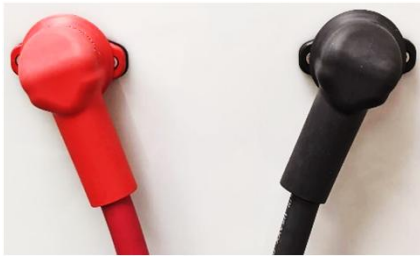

Cable and Terminal Selection Guidelines

courtesy of Rebling.com

December 14, 2023

Product Category	Industry Standard or Test Results	Product			Tool Required for Mating & Un-mating	Cross Sectional Area of Conductor mm <sup>2</sup>	# amps for 30° C Rise 55° total	# amps for 45° C Rise 70° total	# amps for 60° C Rise 85° total	# amps for 90° C Rise 115° total
Connector	Test Results	Rebling	BFT or XFT	1,000 amp rating with one 380 mm <sup>2</sup> cable per terminal	Wrench	390	1,010	1,250	1,430	1,690
Connector	Test Results	Rebling	BFT or XFT	750 amp rating with one 380 mm <sup>2</sup> cable per terminal	Wrench	390	900	1,100	1,250	1,440
Connector	Test Results	Rebling	MFT or Top Seal	500 amp rating with one 230 mm <sup>2</sup> cable per terminal	Wrench	240	520	630	730	840
Connector	Test Results	Rebling	LFT, SFT, Top Seal	250 amp rating with one 105 mm <sup>2</sup> cable per terminal	Wrench	130	280	340	390	450
Connector	Test Results	Anderson	SB350	with one 105 mm <sup>2</sup> cable per terminal	None	130	280	340	390	450
Connector	Test Results	Rebling	7010+7020	with one 105 mm <sup>2</sup> cable per terminal	None	75	270	330	380	430
Connector	Test Results	Rebling	TFT	100 amp rating with one 32 mm <sup>2</sup> cable per terminal	Wrench	40	115	150	170	190
Cable	Test Results	750 MCM	Cable	7,600 strands of 30 gauge wire		380	1,020	1,270	1,470	
Cable	Test Results	450 MCM	Cable	4,500 strands of 30 gauge wire		230	550	660	770	
Cable	Test Results	250 MCM	Cable	2,500 strands of 30 gauge wire		130	360	450	520	
Cable	Test Results	4/0	Cable	2,060 strands of 30 gauge wire		105	290	350	400	
Cable	Test Results	3/0	Cable	1,590 strands of 30 gauge wire		80	260	310	350	
Cable	Test Results	2/0	Cable	1,280 strands of 30 gauge wire		65	240	290	335	
Cable	Test Results	1/0	Cable	1,000 strands of 30 gauge wire		50	230	270	315	
Cable	Test Results	2 AWG	Cable	625 strands of 30 gauge wire		32	120	160	180	
Cable	Test Results	4 AWG	Cable	375 strands of 30 gauge wire		19	90	105	120	
Cable	Test Results	6 AWG	Cable	260 strands of 30 gauge wire		13	80	100	110	
Cable	Test Results	8 AWG	Cable	160 strands of 30 gauge wire		8.1	75	90	105	
Cable	Test Results	10 AWG	Cable	105 strands of 30 gauge wire		5.3	50	60	70	
Cable	Test Results	12 AWG	Cable	65 strands of 30 gauge wire		3.3	35	40	50	
Cable	Test Results	14 AWG	Cable	40 strands of 30 gauge wire		2.0	20	25	30	
Cable	NEC/UL Std	4/0	Cable	2,060 strands of 30 gauge wire		105	195	230	260	
Cable	NEC/UL Std	2/0	Cable	1,280 strands of 30 gauge wire		65	145	175	195	
Cable	NEC/UL Std	1/0	Cable	1,000 strands of 30 gauge wire		50	125	150	170	
Cable	NEC/UL Std	2 AWG	Cable	625 strands of 30 gauge wire		32	95	115	130	
Cable	NEC/UL Std	6 AWG	Cable	260 strands of 30 gauge wire		13	55	65	75	

**Cable and Connector Selection Guidelines:** The cross sectional areas of the terminal and the cable attached to the terminal should be the same. Attaching a small cable to a large terminal is like attaching a 1 inch pipe to a 4 inch fitting, the size of the cable will limit the system's electrical and thermal performance, not the terminal. To select the optimal connector, follow the steps below:

- Step 1: determine the temperature rise your equipment design can tolerate. The higher the temperature rise your equipment can tolerate, the lower the cost of cable and connectors.
- Step 2: determine if your equipment needs to comply with UL, NEC, IEC or other standards
- Step 3: determine the steady state current which your equipment must handle. If there are frequent or extended peaks of higher currents, use these peaks to estimate an average steady state current.
- Step 4: select the smallest cable which can carry your steady state current which does not exceed the temperature rise you can tolerate and which conforms to the standard with which you wish to comply.
- Step 5: determine if your equipment needs a separable electrical connection. Separable connections are more expensive and less reliable than permanent (soldered or welded) connections.
- Step 6: determine if it is acceptable to use a tool to un-mate your electrical connection. Tool-less connectors are more expensive and less reliable than connectors which require tools but might be justifiable if: frequent un-matings occur, the installer is unskilled, a 20 second reduction in maintenance time is critical or lowered assembly labor costs offset the increased cost of the tool-less connector.
- Step 7: select the lowest cost connector which: does not exceed the temperature rise your equipment can tolerate at your steady state current and meets your un-mating tool requirements.

**Temperature Rise Values:** the NEC (National Electrical Code) values are NEC's recommendations for typical thermoplastic insulated cables enclosed in a conduit which are close to other cables. UL has adopted NEC's 45° C rise values as their recommendations for current levels per cable size in UL 98. The values labeled "Test Results" were obtained from current vs temperature rise testing of individual cables and connectors suspended in air inside an 18" x 18" x 18" test chamber. Lithium battery system designers usually select components which keep the temperature rise to a maximum of 30° C due the sensitivity of lithium cells. It is wise to compare connectors based upon temperature rise test results since the rated currents and total allowable temperatures defined by standards like UL1977 and IEC 61984 can vary by a factor of 2.5. The current vs temperature rise characteristics of your application may be significantly different than the assumptions used in NEC, UL or IEC standards.

**Touch Safe Temperatures:** IEC/UL 60950-1 defines the maximum allowable temperature for 3 seconds of contact between a metal component and the human body as 60° C; for plastic it's 85° C.

**Cross Sectional Area of Conductor:** the cross sectional areas of the stranded cables shown above were calculated using the diameter of one 30 gauge wire = 0.01000 inches



# Dimensions & Specifications

**100 amp  
TFT**

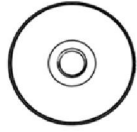

**250 amp  
LFT**

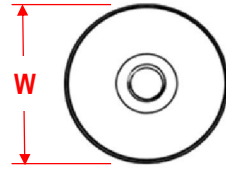

**250 amp SFT & 500 amp MFT**

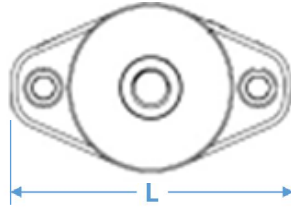

**250 or 500 amp  
Top Seal**

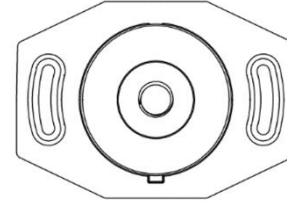

**750 or 1,000 amp  
BFT**

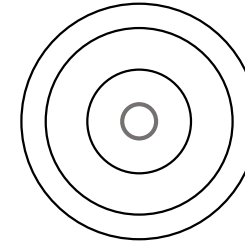

**750 or 1,000 amp  
XFT**

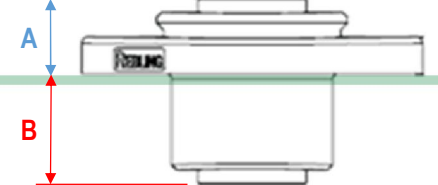
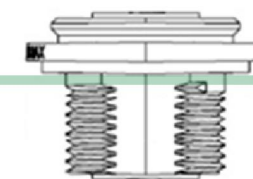
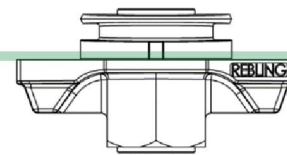
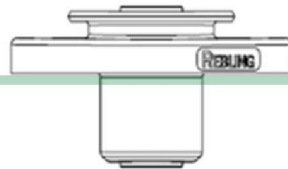
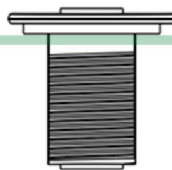
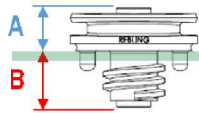
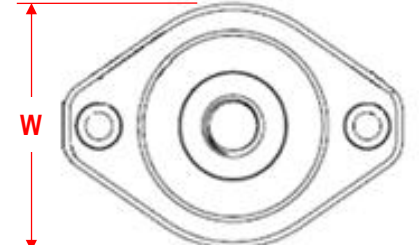

Distance from the external panel surface to the terminal's external contact surface

Distance from the external panel surface to the terminal's internal contact surface

Parameter	TFT	LFT	SFT	MFT	Top Seal	BFT	XFT
Rated Current (amps)	100	250	250	500	250 or 500	750 or 1,000	750 or 1,000
Peak Current (amps)	600	1,500	1,500	3,000	1,500 or 3,000	4,000 or 5,000	4,000 or 5,000
Electrical Connection Bolt Size	M5 or 10-32	M8	M8 or 5/16	M8 or 5/16	M8	5/16	M10 or 3/8
Dia of Terminal's Conductor	0.28" (7.1mm)	0.50" (12.7mm)	0.50" (12.7mm)	0.69" (17.5mm)	0.50" (12.7mm) or 0.69" (17.5mm)	0.88" (22.2mm)	0.88" (22.2mm)
"W" Dimension	1.03" (26.2mm)	1.34" (34.0mm)	1.34" (34.0mm)	1.34" (34.0mm)	1.74" (44.2mm)	1.96" (49.8mm)	1.95" (49.5mm)
"L" Dimension	1.03" (26.2mm)	1.34" (34.0mm)	2.25" (57.2mm)	2.25" (57.2mm)	2.47" (62.7mm)	1.96" (49.8mm)	2.75" (69.9mm)
"A" Dimension w No gasket	0.35" (8.9mm)	0.20" (5.1mm)	0.53" (13.5mm)	0.53" (13.5mm)	0.45" (11.4mm) – Panel Thickness	0.49" (12.5mm)	0.54" (13.7mm)
"B" Dimension w No gasket	0.46" (11.7mm)	1.07" (27.2mm)	0.74" (18.8mm)	0.74" (18.8mm)	0.82" (20.8mm) + Panel Thickness	0.86" (21.8mm)	0.95" (24.1mm)
"A" Dimension with gasket	0.35" (8.9mm)	0.28" (7.1mm)	0.61" (15.5mm)	0.61" (15.5mm)	0.45" (11.4mm) – Panel – Gasket(s)	0.57" (14.5mm)	0.62" (15.7mm)
"B" Dimension with gasket	0.46" (11.7mm)	0.99" (25.1mm)	0.66" (16.8mm)	0.66" (16.8mm)	0.82" (20.8mm) + Panel + Gasket(s)	0.78" (19.8mm)	0.87" (22.1mm)
IP Rating w Gasket or O-ring	IP68-watertight	IP68-watertight	IP68-watertight	IP68-watertight	IP68-watertight	IP68-watertight	IP68-watertight
Recommended Panel Material	Metal or Plastic	Metal	Metal or Plastic	Metal or Plastic	Metal or Plastic	Metal	Metal or Plastic
Min Panel Thickness	0.025" (0.6mm)	0.11" (2.8mm)	0.025" (0.6mm)	0.025" (0.6mm)	0.040" (1.0mm)	0.080" (2.1mm)	0.025" (0.6mm)
Max Panel Thickness	0.157" (4.0mm)	0.70" (17.8mm)	0.55" (14.0mm)	0.55" (14.0mm)	0.185" (4.7mm)	0.50" (12.7mm)	0.70" (17.8mm)
Panel Mounting Method	Panel Nut	Panel Nut	Panel Screws	Panel Screws	Flat Head Sheet Metal Screws	Panel Nut	Panel Screws
UL94 Flammability	V-0	5VA	V-0	V-0	V-0	5VA	V-0

**Terminal Selection Guide**

Your Application's Parameters					Rebling Terminal Selection Guide				Accessories					
Rated Current	Your Panel	Your Panel Thickness	Desired Panel Mounting	Connector Plating	Style	Insulator Color	P/N for bagged Kit	Advantages over other Styles	O-ring	Gasket	Flexible Cover	Long Rigid Cover	Short Rigid Cover	
100 amps	Plastic or Metal	0.025 → 0.157" 0,64 → 4,0 mm	3 circular holes	Ni-plated Brass	TFT	Black Red Blue	TFT-P-B TFT-P-R TFT-P-E	Can be mounted on very thin or weak panels Mounting holes can be made with a hand drill	812A1925	-	815A1927-B (BLK) 815A1927-R (RED) 815A1927-E (BLU)	814A1926-B (BLK) 814A1926-R (RED) 814A1926-E (BLU)	-	
250 amps	Plastic	0.025 → 0.220" 0,64 → 5,59 mm	3 circular holes	Ni-plated Brass	SFT	Black Red Blue	SFT-P-B SFT-P-R SFT-P-E	Can be mounted on very thin or weak panels Mounting holes can be made with a hand drill	-	716A1814	713A1806-B (BLK) 713A1806-R (RED) 713A1806-E (BLU)	698A1789-L-B (BLK) 698A1789-L-R (RED) 698A1789-L-E (BLU)	698A1789-S-B (BLK) 698A1789-S-R (RED) 698A1789-S-E (BLU)	
			1 double-D hole	Ni-plated Brass	LFT	Black Red Blue	LFT-P-B LFT-P-R LFT-P-E	Smallest Footprint, Lowest Cost Simplest Environmental Seal	700A1799	-				
		3 circular holes	Ni-plated Brass	SFT	Black Red Blue	SFT-P-B SFT-P-R SFT-P-E	Can be mounted on very thin or weak panels Mounting holes can be made with a hand drill	-	716A1814					
	Metal	0.025 → 0.100" 0,64 → 2,54 mm	3 circular holes	Ni-plated Brass	SFT	Black Red Blue	SFT-P-B SFT-P-R SFT-P-E	Can be mounted on very thin or weak panels Mounting holes can be made with a hand drill	-	716A1814				
			1 double-D hole	Ni-plated Brass	LFT	Black Red Blue	LFT-P-B LFT-P-R LFT-P-E	Smallest Footprint, Lowest Cost Simplest Environmental Seal	700A1799	-				
		3 circular holes	Ni-plated Brass	SFT	Black Red Blue	SFT-P-B SFT-P-R SFT-P-E	Can be mounted on very thin or weak panels Mounting holes can be made with a hand drill	-	716A1814					
500 amps	Plastic or Metal	0.025 → 0.660" 0,64 → 16,76 mm	3 circular holes	Ni-plated Brass	MFT	Black Red Blue	MFT-P-B MFT-P-R MFT-P-E	Can be mounted on very thin or weak panels Mounting holes can be made with a hand drill	-	716A1815				
750 amps	Plastic	0.025 → 0.180"	3 circular holes	Ni-plated Brass	XFT	Black Red	XFT-P-B XFT-P-R	Can be mounted on very thin or weak panels Mounting holes can be made with a hand drill	-	720A1817	639A1830-B (BLK) 639A1830-R (RED)	-	-	
	Plastic	0.190 → 0.550" 4,83 → 13,97 mm	1 double-D hole	Ni-plated Brass	BFT	Black Red	BFT-P-B BFT-P-R	Smallest Footprint, Lowest Cost Simplest Environmental Seal		651A1811				648A1758 (BLK) 648A1779 (RED)
			3 circular holes	Ni-plated Brass	XFT	Black Red	XFT-P-B XFT-P-R	Can be mounted on very thin or weak panels Mounting holes can be made with a hand drill		720A1817				-
	Metal	0.025 → 0.070"	3 circular holes	Ni-plated Brass	XFT	Black Red	XFT-P-B XFT-P-R	Can be mounted on very thin or weak panels Mounting holes can be made with a hand drill		720A1817				-
			1 double-D hole	Ni-plated Brass	BFT	Black Red	BFT-P-B BFT-P-R	Smallest Footprint, Lowest Cost Simplest Environmental Seal		651A1811				648A1758 (BLK) 648A1779 (RED)
			3 circular holes	Ni-plated Brass	XFT	Black Red	XFT-P-B XFT-P-R	Can be mounted on very thin or weak panels Mounting holes can be made with a hand drill		720A1817				-
1000 amps	Plastic	0.025 → 0.180"	3 circular holes	Ni-plated Copper	XFT	Black Red	XFT-N-B XFT-N-R	Can be mounted on very thin or weak panels Mounting holes can be made with a hand drill	-	720A1817	639A1830-B (BLK) 639A1830-R (RED)	-	-	
			1 double-D hole	Ni-plated Copper	BFT	Black Red	BFT-N-B BFT-N-R	Smallest Footprint, Lowest Cost Simplest Environmental Seal		651A1811				648A1758 (BLK) 648A1779 (RED)
		3 circular holes	Ni-plated Copper	XFT	Black Red	XFT-N-B XFT-N-R	Can be mounted on very thin or weak panels Mounting holes can be made with a hand drill	720A1817		-				
	Metal	0.025 → 0.070"	3 circular holes	Ni-plated Copper	XFT	Black Red	XFT-N-B XFT-N-R	Can be mounted on very thin or weak panels Mounting holes can be made with a hand drill		720A1817				-
			1 double-D hole	Ni-plated Copper	BFT	Black Red	BFT-N-B BFT-N-R	Smallest Footprint, Lowest Cost Simplest Environmental Seal		651A1811				648A1758 (BLK) 648A1779 (RED)
			3 circular holes	Ni-plated Copper	XFT	Black Red	XFT-N-B XFT-N-R	Can be mounted on very thin or weak panels Mounting holes can be made with a hand drill		720A1817				-



# Feed-through Terminals

Covers and Gaskets can be found on the Accessories Page

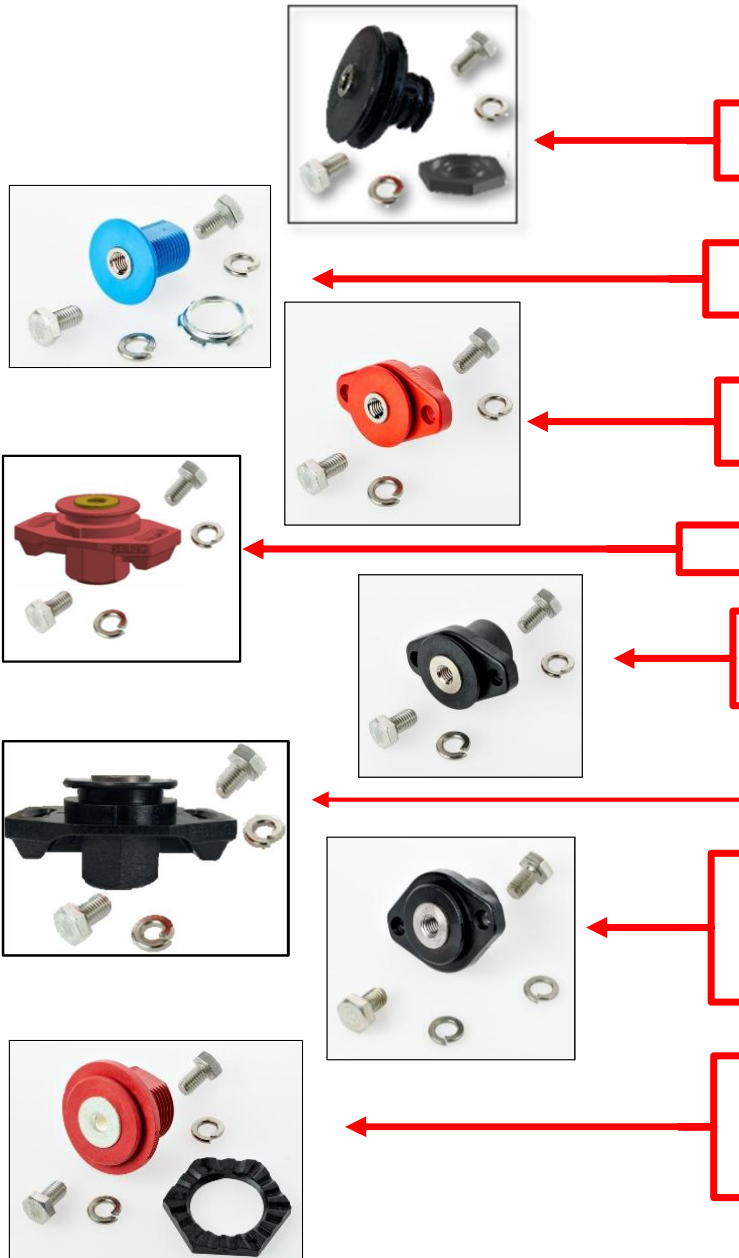

P/N	Description
TFT-P-B TFT-P-R TFT-P-E	100 amp Lithium Battery Terminal, Brass, Nickel plated w M5 bolts (Black, Red, Blue)
LFT-P-B LFT-P-R LFT-P-E	250 amp Lithium Battery Terminal, Brass, Nickel plated w M8 bolts (Black, Red, Blue)
SFT-P-B SFT-P-R SFT-P-E	250 amp Lithium Battery Terminal, Brass, Nickel plated w M8 bolts (Black, Red, Blue)
Top250-P-R Top250-P-B	250 amp Lithium Battery Terminal, Brass, Nickel plated w M8 bolts (Black, Red)
MFT-P-B MFT-P-R MFT-P-E	500 amp Lithium Battery Terminal, Brass, Nickel plated w M8 bolts (Black, Red, Blue)
Top500-P-R Top500-P-B	500 amp Lithium Battery Terminal, Brass, Nickel plated w M8 bolts (Black, Red)
XFT-P-B XFT-P-R	750 amp Lithium Battery Terminal, Brass, Nickel plated w M10 bolts (Black or Red)
XFT-N-B XFT-N-R	1000 amp Lithium Battery Terminal, Copper, Nickel plated w M10 bolts (Black or Red)
BFT-P-B BFT-P-R	750 amp Lithium Battery Terminal, Brass, Nickel plated w 5/16 bolts (Black or Red)
BFT-N-B BFT-N-R	1,000 amp Lithium Battery Terminal, Copper, Nickel plated w 5/16 bolts (Black or Red)

**Pricing and Delivery**  
please contact these  
Authorized Distributors

**North and South America**  
Flame Enterprises  
[FlameCorp.com](http://FlameCorp.com)

Vandapower-USA  
[Vandapower.com/us](http://Vandapower.com/us)

Bisco Industries  
[BiscoInd.com](http://BiscoInd.com)

**Europe, Middle East, Africa**  
Vandapower-Belgium  
[Vandapower.com](http://Vandapower.com)

**Australia & Asia**  
Vandapower-Belgium  
[Vandapower.com](http://Vandapower.com)

Flame Enterprises  
[FlameCorp.com](http://FlameCorp.com)



## Top Seal Terminal

The **Top Seal Terminal** saves the OEM \$15 of material and labor on each battery produced and reduces each battery's volume by 200 cc. The Top Seal eliminates 20 inches (500 mm) of cable + 4 crimp lugs + production labor from each battery. The Top Seal is intended for OEMs which are graduating from producing hundreds of batteries per year to tens or hundreds of thousands per year.

The 250 and 500 amp **Top Seal Terminals** use the same nickel-plated brass conductor, accept the same rigid and flexible covers and have the same performance characteristics as Rebling's 250 amp SFT and 500 amp MFT feed-through terminals. They are intended for lithium battery OEMs which are packaging their cell packs inside molded plastic or aluminum cases that are 1 to 20 times the size of an automotive starter battery.

The Top Seal Terminal enables the OEM to attach the terminal to the lithium cell pack first, place the cell pack into the battery case, place the lid onto the battery case (allowing the terminals to poke through clearance holes in the lid), attach the lid to the terminals with flat-head sheet metal screws then screw, glue or weld the battery lid to the battery case.

Includes an "Arc of Forgiveness" feature, allowing the terminal to be mis-rotated by 30 degrees (+ or - 15°) and still align the terminal's pilot hole slot with the flat-head screw mounting holes in the battery lid. OEMs wishing to take advantage of the Arc of Forgiveness need to cut their battery lid's mounting hole pattern to allow the "Orientation Key" to rotate though an arc.

Includes an "Orientation Key" that stands proud of the centering collar, allowing high precision OEMs to better align the terminal.

Includes a hex section to facilitate tightening the terminal to the cell pack's bus bar/ bus plate.

The optional 0.060" (1.5mm) thick gasket is placed on top of the terminal's flange to seal between the battery lid and the terminal. Up to 3 gaskets can be stacked to achieve the terminal-to-lid dimension desired by the OEM.

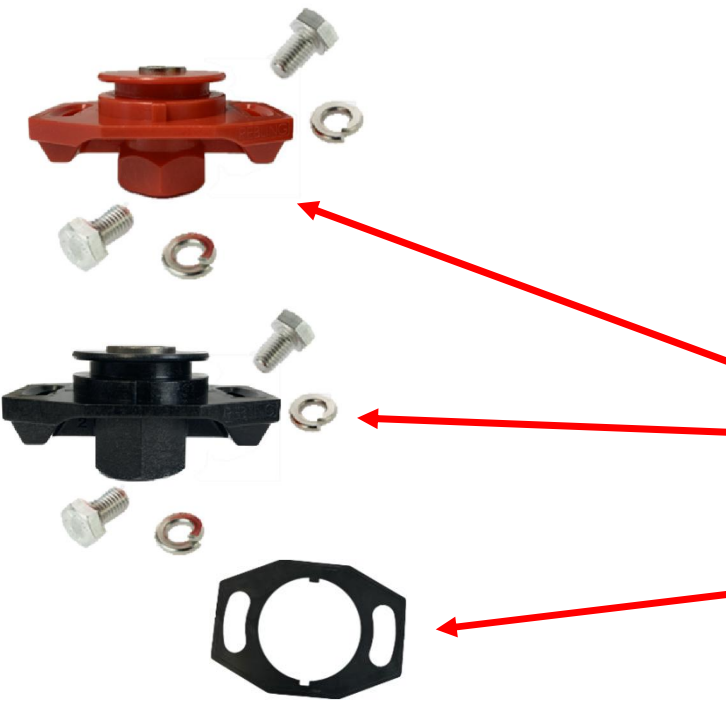
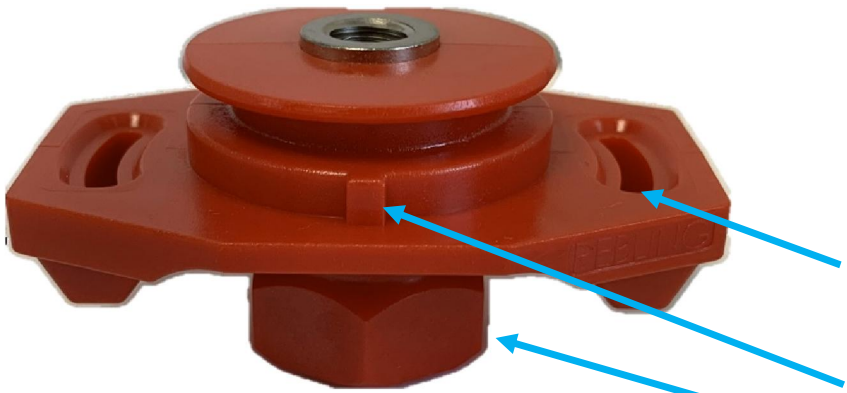

P/N	Description	Pricing
Top250-P-B	250 amp Top Seal Terminal Kit, Brass, Nickel plated w M8 Bolts, Black	<b>Pricing and Delivery</b> please contact these Authorized Distributors  <b>Flame Enterprises</b> <a href="http://FlameCorp.com">FlameCorp.com</a>  <b>Vandapower</b> <a href="http://Vandapower.com">Vandapower.com</a>
Top250-P-R	250 amp Top Seal Terminal Kit, Brass, Nickel plated w M8 Bolts, Red	
Top500-P-B	500 amp Top Seal Terminal Kit, Brass, Nickel plated w M8 Bolts, Black	
Top500-P-R	500 amp Top Seal Terminal Kit, Brass, Nickel plated w M8 Bolts, Red	
821A1951	Gasket for 250 amp & 500 amp Top Seal Terminal	



## Fixed-Orientation Terminals

Some applications, especially automotive, require that a cable be attached to a terminal in a specific orientation. This terminal has orientation ridges that allow a cable lug to only be attached to the terminal perpendicular to the centerline of the mounting holes. A Fixed-orientation Terminal assures that a complex automotive cable harness, which might be 12 feet in length and have 20 different power and signal connectors attached, can only be installed on the vehicle in one of two orientations. See datasheets for orientation ridge dimensions.

Fixed-Orientation TFT & SFT Terminals have the same Performance Characteristics and accept the same Flexible Covers and Gaskets as their Standard Terminal Counterparts



P/N	Description	Pricing
TFT-P-B-070	100 amp Fixed-orientation Terminal, Brass, Nickel plated w M5 Bolts, Black	<b>Pricing and Delivery</b> please contact these Authorized Distributors  <b>Flame Enterprises</b> <a href="http://FlameCorp.com">FlameCorp.com</a>  <b>Vandapower</b> <a href="http://Vandapower.com">Vandapower.com</a>
TFT-P-R-070	100 amp Fixed-orientation Terminal, Brass, Nickel plated w M5 Bolts, Red	
TFT-P-E-070	100 amp Fixed-orientation Terminal, Brass, Nickel plated w M5 Bolts, Blue	
SFT-P-B-087	250 amp Fixed-orientation Terminal, Brass, Nickel plated w M8 Bolts, Black	
SFT-P-R-087	250 amp Fixed-orientation Terminal, Brass, Nickel plated w M8 Bolts, Red	
SFT-P-E-087	250 amp Fixed-orientation Terminal, Brass, Nickel plated w M8 Bolts, Blue	





# Imperial-threaded Feed-through Terminals

Imperial-threaded fasteners have been the standard on military and civilian aircraft worldwide for over 100 years  
 These Terminals are used on Avionics Power Distribution Panels, Power Conditioning Modules, UAVs and EV Passenger Planes

Imperial-threaded Terminals have the same Performance Characteristics and accept the same Covers and Gaskets as their metric-threaded equivalents



P/N	Description	Pricing
TFT-P-B-070 TFT-P-R-070 TFT-P-E-070	250 amp Lithium Battery Terminal, Brass, Nickel plated w 5/16 bolts (Black, Red, Blue)	<p><b>Pricing and Delivery</b></p> <p>Imperial-threaded Terminals are available Worldwide <b>exclusively</b> through Rebling's Authorized Distributor</p> <p><b>Flame Enterprises</b> FlameCorp.com</p>
SFT-P-B-516 SFT-P-R-516 SFT-P-E-516	250 amp Lithium Battery Terminal, Brass, Nickel plated w 5/16 bolts (Black, Red, Blue)	
MFT-P-B-516 MFT-P-R-516	500 amp Lithium Battery Terminal, Brass, Nickel plated w 5/16 bolts (Black or Red)	
XFT-N-B-38 XFT-N-R-38	1000 amp Lithium Battery Terminal, Copper, Nickel plated w 3/8 bolts (Black or Red)	
BFT-P-B BFT-P-R	750 amp Lithium Battery Terminal, Brass, Nickel plated w 5/16 bolts (Black or Red)	
BFT-N-B BFT-N-R	1,000 amp Lithium Battery Terminal, Copper, Nickel plated w 5/16 bolts (Black or Red)	

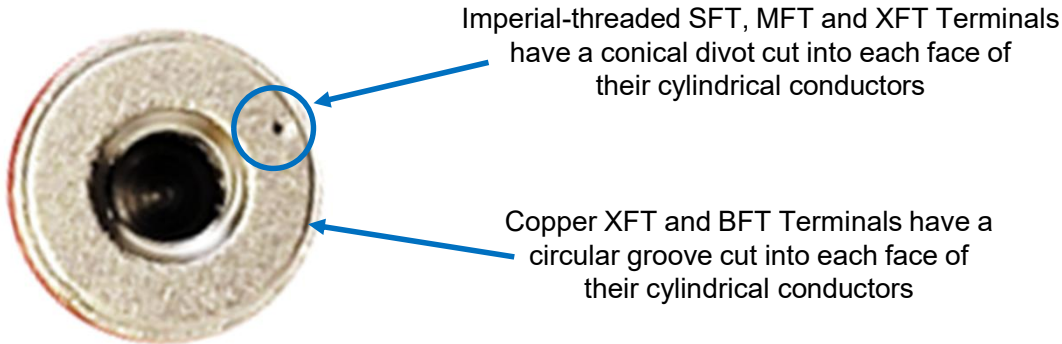

Imperial-threaded SFT, MFT and XFT Terminals have a conical divot cut into each face of their cylindrical conductors

Copper XFT and BFT Terminals have a circular groove cut into each face of their cylindrical conductors



## Accessories for Feed-through Terminals

The Accessories shown below fit all Metric-threaded and Imperial-threaded Terminals

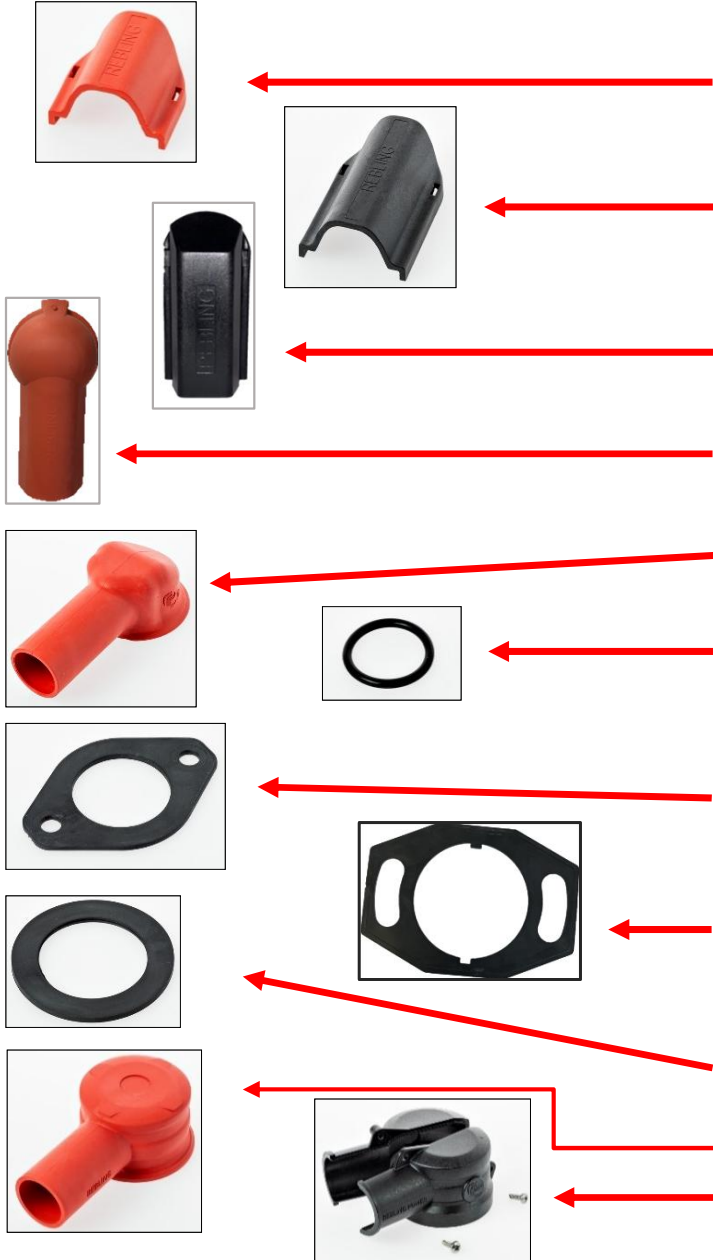

P/N	Description
698A1789-S-B 698A1789-S-R 698A1789-S-E	Short Rigid Cover for LFT, SFT, MFT or Top Seal terminals (1.44" OAL) (Black, Red or Blue)
698A1789-L-B 698A1789-L-R 698A1789-L-E	Long Rigid Cover for LFT, SFT, MFT or Top Seal terminals (2.23" OAL) (Black, Red or Blue)
814A1926-B 814A1926-R 814A1926-E	Rigid Cover for TFT terminal (Black, Red or Blue)
815A1927-B 815A1927-R 815A1927-E	Flexible Cover for TFT terminal (Black, Red or Blue)
713A1806-B 713A1806-R 713A1806-E	Flexible Cover for LFT, SFT, MFT or Top Seal terminals (3.70" OAL, 0.82" ID) (Black, Red or Blue)
812A1925	O-Ring for TFT terminal
700A1799	O-Ring for LFT terminal
716A1814	Gasket for SFT terminal
716A1815	Gasket for MFT terminal
821A1951	Gasket for 250 or 500 amp Top Seal Terminals
720A1817	Gasket for XFT terminal
651A1811	Gasket for BFT terminal, 1.95" OD
639A1830-B 639A1830-R	Flexible Cover for BFT or XFT terminals (3.50" OAL, 0.82" ID) (Black or Red)
648A1758 (Black) 648A1779 (Red)	Rigid, 2 piece, Outer Cover for BFT terminal (3.85" OAL, 1.05" ID) (Black or Red)

**Pricing and Delivery**  
please contact these  
Authorized Distributors

**North and South America**  
Flame Enterprises  
[FlameCorp.com](http://FlameCorp.com)

Vandapower-USA  
[Vandapower.com/us](http://Vandapower.com/us)

Bisco Industries  
[BiscoInd.com](http://BiscoInd.com)

**Europe, Middle East, Africa**  
Vandapower-Belgium  
[Vandapower.com](http://Vandapower.com)

**Australia & Asia**  
Vandapower-Belgium  
[Vandapower.com](http://Vandapower.com)

Flame Enterprises  
[FlameCorp.com](http://FlameCorp.com)

# Double Pole, Bulkhead-mounted, Quick-Disconnect Receptacles

## 7010 Series

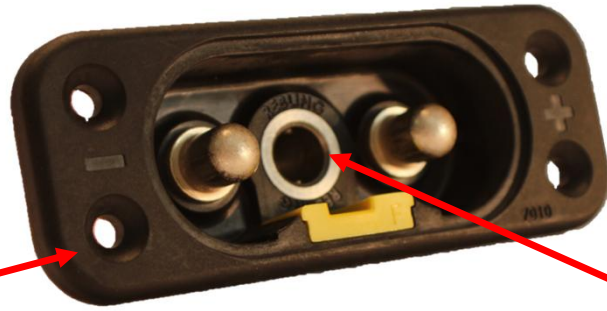

1.62" Overall Height  
4.30" Overall Width  
1.60" Overall Depth

Bulkhead-mounted, Keyable Receptacle (7010-3)

The shaft of the handle on our cable-mounted connector locks into this socket.



Cables with crimped terminal lugs can be attached to these rear threaded posts

Bulkhead-mounted Receptacle with EMI-ESD Shielding (7009-51)



Elastomeric Gasket with Dust Cover (685A1766)



Receptacle with Gasket and Dust Cover installed



Dust Cover closed



# Double Pole, Cable-mounted, Quick-Disconnect Plugs

## 7020 Series



Two Wire with non-conductive black backshell (7020-T)



Two Wire with non-conductive orange backshell (7020-O)



Two Wire with EMI-ESD conductive gray backshell (7020-E)

Rotate the Handle clockwise to engage. It gives positive tactile and visual feedback when mated

Four Wire, Double Pole, Tee Handle (7007-3)



Four Wire, Double Pole, Round Handle (7007)

# Series and Parallel Configurations



Two Wire with non-conductive black backshell (7020-T)



Series Configuration



Two Wire with EMI-ESD conductive gray backshell (7020-E)



Four Wire, Tee Handle (7007-3)



Parallel Configuration

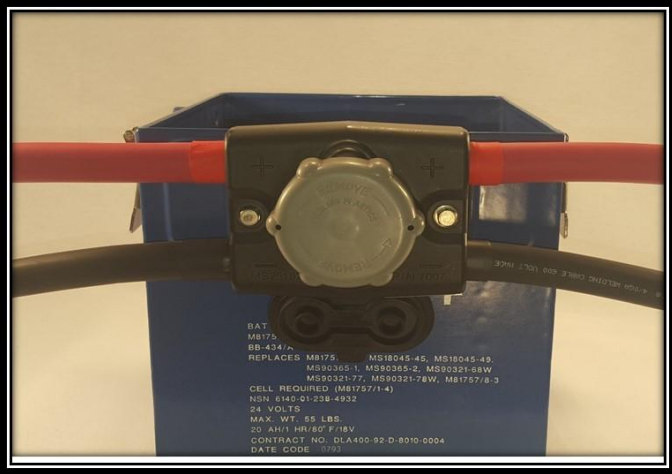

Four Wire, Round Handle (7007)

# HVIL and EMI-ESD Versions

Cable-mounted Plug with High Voltage Interlock

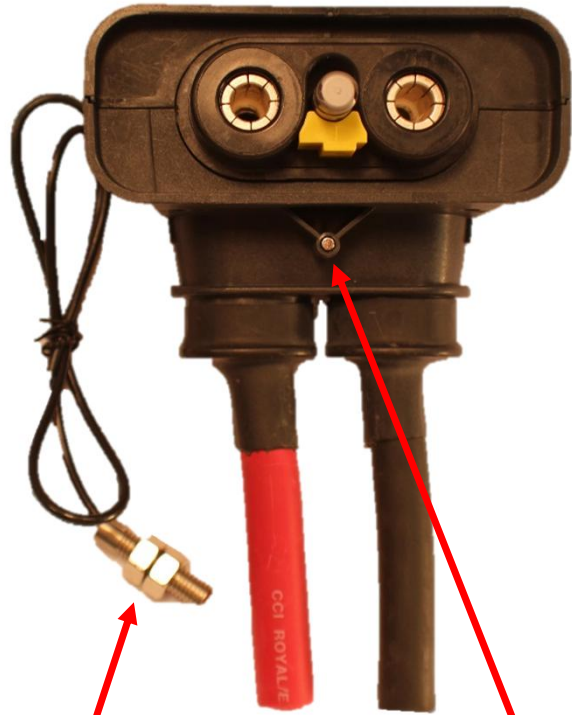

Magnetic Micro Switch is activated by the neodymium magnet to actuate the contactor in your switching cabinet

1/8" x 5/8" neodymium magnet installed in backshell  
Magnet + Micro Switch = kit # 643A1757

Cable-mounted Plug with EMI-ESD Conductive Backshell

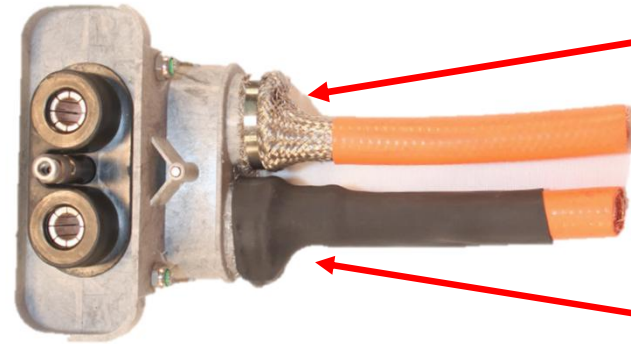

Braided cable shield can be flared-out or pig-tailed then attached to the conductive plastic backshell with a zip tie

Shrink tubing can be applied to cover the braided shield



To measure the resistivity of any conductive fiber infused plastic with a multimeter, use a probe with a 10mm diameter tip

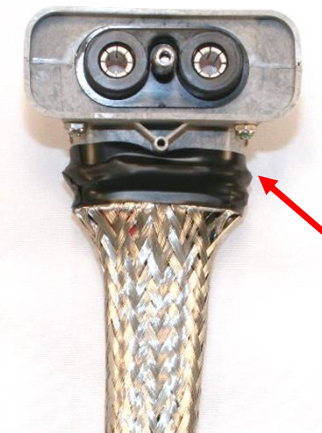

A shielded sleeve can be used to surround un-shielded cable. The sleeve can be attached to the conductive backshell with a zip tie.

Shrink tubing or tape can be applied to cover the end of the sleeve.

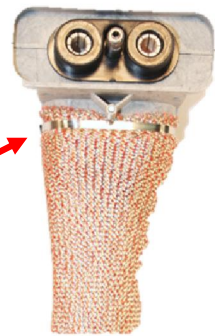

# Assembly Process

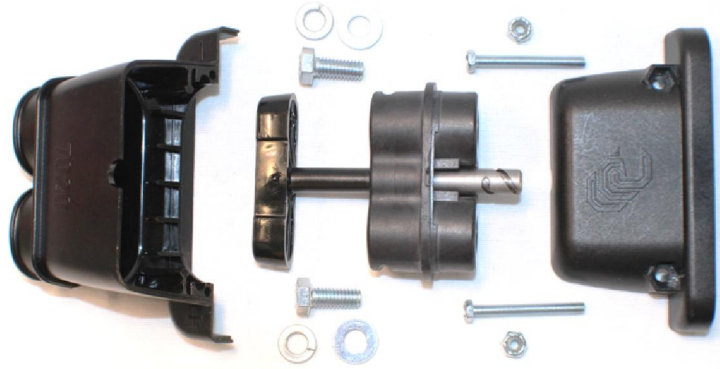

Cable-mounted Plug with Black Backshell (7020-T)



Attach terminal lugs (purchased separately) to the cable size appropriate for your application (8 AWG – 4/0)



Attach the terminal lugs to the threaded holes in our connector using the bolts and washers in our kit

Plug and Receptacle mated



Shrink Tubing can be applied between the cable and the backshell to achieve sealing

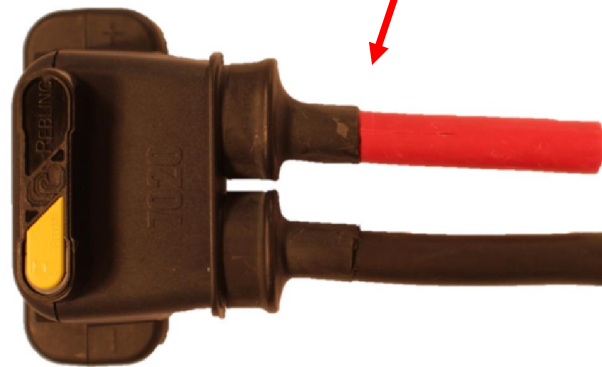

Attach the backshell



## Dimensions & Specifications

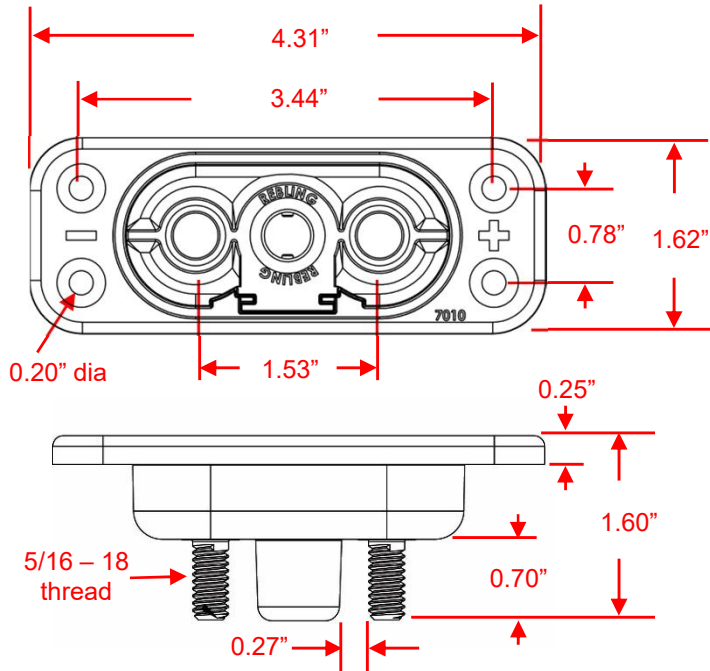

### 7010 Series

Rated Current = 500 amps  
 Peak Current = 3,000 amps for 1 second  
 Rated Voltage = 1,500 volts  
 IP68 when mounted with gasket  
 UL94 V-0 Flammability Rating  
 Torque on electrical connections:  
 Nominal 30 – 40 in-lbs Max 60 in-lbs

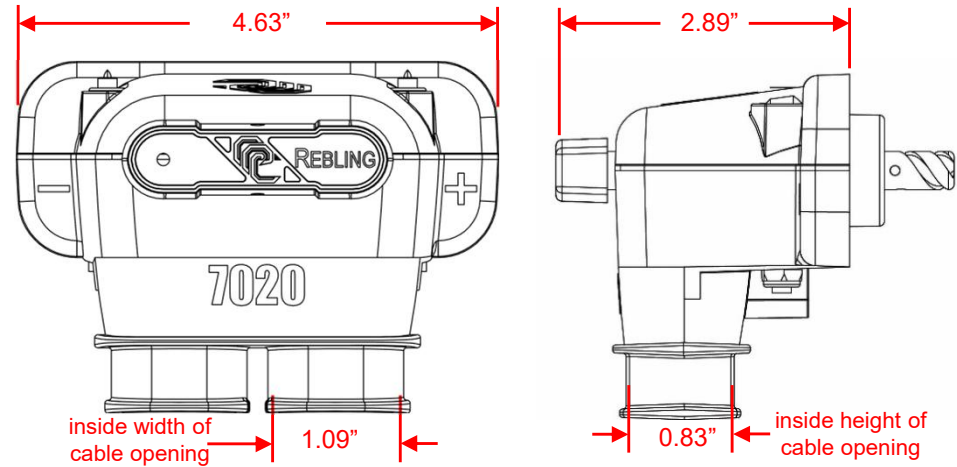

### 7020 Series

Rated Current = 500 amps  
 Peak Current = 3,000 amps for 1 second  
 Rated Voltage = 1,500 volts  
 IP56 when shrink tubing is applied  
 UL94 V-0 Flammability Rating  
 Torque on electrical connections:  
 Nominal 30 – 40 in-lbs Max 60 in-lbs  
 Torque on backshell bolts: 6 – 8 in-lbs

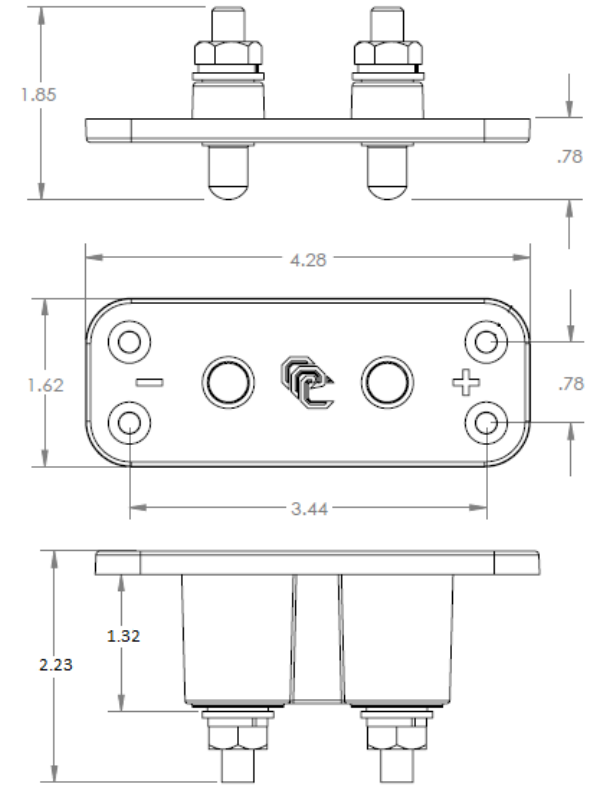

### Battery Swap

Rated Current = 500 amps  
 Peak Current = 3,000 amps for 1 second  
 Rated Voltage = 1,000 volts  
 UL94 V-0 Flammability Rating  
 Torque on electrical connections:  
 Nominal 30 – 40 in-lbs Max 60 in-lbs



## Quick-Disconnect Connectors and Accessories



P/N	Description	Pricing
7010-3	Bulkhead-mounted Receptacle, Keyable, Threaded posts, Black	<p><b>Pricing and Delivery</b> please contact these Authorized Distributors</p> <p><b>North and South America</b> Flame Enterprises <a href="http://FlameCorp.com">FlameCorp.com</a></p> <p>Vandapower-USA <a href="http://Vandapower.com/us">Vandapower.com/us</a></p> <p>Bisco Industries <a href="http://BiscoInd.com">BiscoInd.com</a></p> <p><b>Europe, Middle East, Africa</b> Vandapower-Belgium <a href="http://Vandapower.com">Vandapower.com</a></p> <p><b>Australia &amp; Asia</b> Vandapower-Belgium <a href="http://Vandapower.com">Vandapower.com</a></p> <p>Flame Enterprises <a href="http://FlameCorp.com">FlameCorp.com</a></p>
684A1763-x	Key for 7010 bulkhead-mounted receptacle (Orange-A, Blue-B, Green-C, Pink-D, White-E, Yellow-F)	
7020-T	Cable-mounted Plug Connector, Keyable, with non-conductive Black Backshell	
684A1765-x	Key Set for 7020 cable-mounted plug (Orange-A, Blue-B, Green-C, Pink-D, White-E, Yellow-F)	
685A1766	Gasket with Attached Dust Cover for 7010 bulkhead-mounted receptacle, Black	
7009-51	Bulkhead-mounted Receptacle Connector, EMI Shielded, Gray	
7020-O	Cable-mounted Plug Connector, Keyable, with non-conductive Orange Backshell	
7020-E	Cable-mounted Plug with EMI-ESD Conductive Gray Backshell	
100A1784 100A1112	Gasket for 7010 bulkhead-mounted receptacle, Black Gasket for Battery Swap Pin or Socket Connectors	
643A1625	EMI conductive gasket for 7009-51 bulkhead-mounted receptacle	
643A1757	HVIL Kit for 7010 and 7020, includes magnet + magnetic switch	
654A1679 654A1680	Battery Swap Male Pin Connector Battery Swap Female Socket Connector	<p><i>Male &amp; Female connectors must be ordered in matching quantities (pairs)</i></p>